

- ※ Extensive operating voltage
DC 12~240V or AC 24~240V
- ※ High capacity relay output 3A/250VAC
- ※ High compact structure IP-65
- ※ Multi surge killer circuit effectively protects from surge damage
- ※ B type (Normal close type)
have no stock maybe ,
accepted order to manufacture
Model : A3R-30XB , A3R-1MXB , A3R-2MXB
A3G-2MRB , A3G-4MXB
A3T-10MXB , A3T-20MXB
- ※ Palarityzd Mirror Relylexyre
(A3G-4MRE)Reflex type available

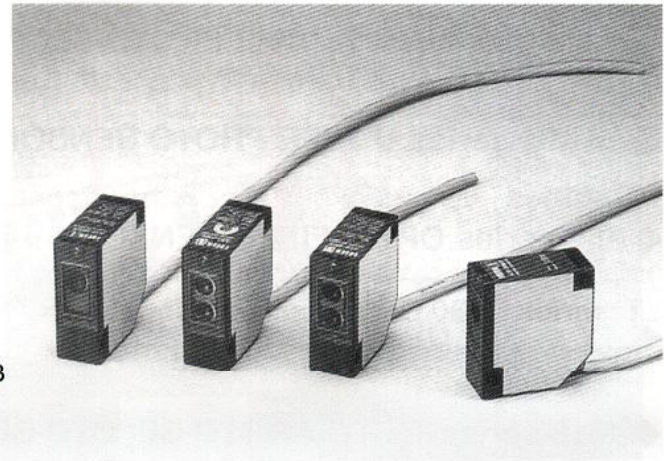

General Specification

Specification	Data
Operating Voltage	12~240 VDC ; 24~240 VAC , 50/60HZ
Current Consumption	2VA max.
Output Method	Relay
Contact Current	5A/250 VAC
Response Time	15ms
Illumination	Lamplight < 10,000 Lux. ; Sunlight < 30,000 Lux.
Connection Method	5 Cores / 6.0 φ X 2m
Noise Resistance	1500Vp - p/1 μS
Surge Resistance	2 KV/1 μ S
Vibration Resistance	10~55Hz / 1.5mm , 2 Hour In X.Y.Z. Direction
Housing Material	Case : Intensive ABS ; Lens : PC
Operating Temp./Hum.	-20 C ~ +60 C ; 35% ~ 85% RH

Connection Diagram

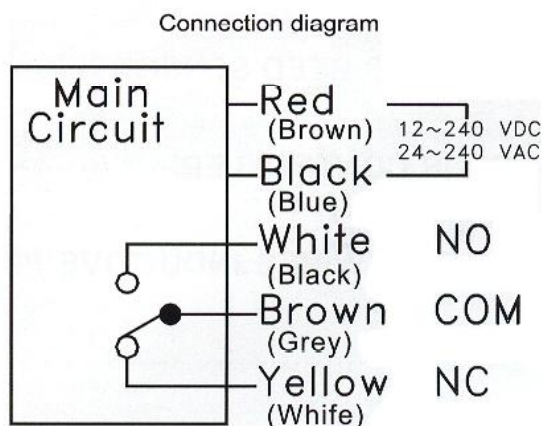

■ Reflex Type

Type	Standard Type			Water-Proof Type		
Model	A3R-30X	A3R-1MX	A3R-2MX	A3R-30XP	A3R-1MXP	A3R-2MXP
Sensing Distance	30cm	100cm	200cm	30cm	100cm	200cm
Protection Class	IP-65			IP-67		
Operating Voltage	12~240 VDC ; 24~240 VAC 50/60Hz					
Output Method	Relay					
Output Status	NO. <Received ON >					
Sensitivity Adjuster	270° Trimmer					
Emitter	Infrared LED					
Min. Sensible Object	5.0 φ					
Weight	Appr.145g			Appr.155g		

■ Mirror Reflex Type

Type	Standard Type				Water-Proof Type	
Model	A3G-2MR	A3G-2MRS	A3G-4MRE	A3G-4MX	A3G-2MRP	A3G-4MXP
Sensing Distance	3m	2m	4m	4m	3m	4.5m
Emitter	Red LED	Red LED	Red LED	Infrared LED	Red LED	Infrared LED
Sensing Adjuster	Trimmer	Without			Trimmer	Without
Protect Class	IP-65				IP-67	
Operating Voltage	12~240 VDC ; 24~240 VAC 50/60Hz					
Output Method	Relay					
Output Status	NO. < Break ON >					
Min. Sensible Object	2.0 φ		5.0 φ		2.0 φ	5.0 φ
Weight	Appr.145g				Appr.155g	

■ Thru Beam Type

Type	Standard Type			Water-Proof Type		
Model	A3T-3MX	A3T-10MX	A3T-20MX	A3T-3MXP	A3T-10MXP	A3T-20MXP
Sensing Distance	3m	10m	20m	3m	10m	20m
Protection Class	IP-65			IP-67		
Operating Voltage	12~240 VDC ; 24~240 VAC 50/60Hz					
Output Method	Relay					
Output Status	NO. < Break ON >					
Emitter	Infrared LED					
Sensitivity Adjuster	Without					
Min. Sensible Object	2.0 φ	5.0 φ	10.0 φ	2.0 φ	5.0 φ	10.0 φ
Weight	Appr.285g			Appr.305g		

A3 series

FREE POWER PHOTO SENSOR

Characteristic Curve < Typical >

Diffuse Reflex type

A3R-1MX

Sensing area

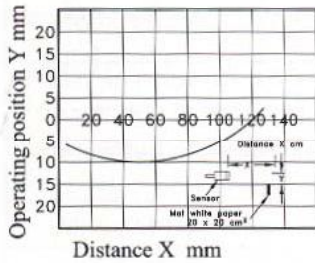

Mirror Reflex type

A3G-2MR/A3G-4MX

Setting range

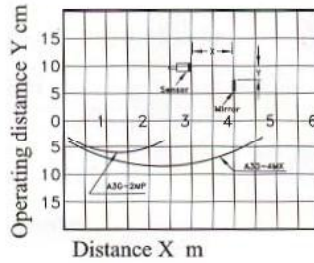

Thru Beam type

A3T-10MX/A3T-20MX

Setting range

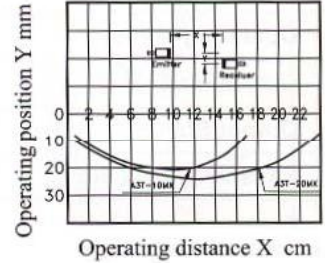

Sensing area

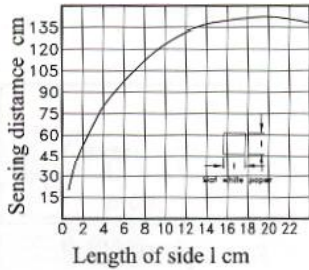

Setting angle

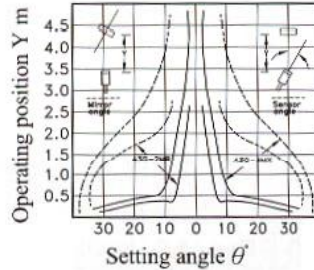

Setting angle

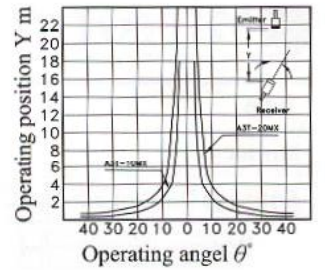

Dimension

