

# Multi-Functional Counter/Timer

## DIN size W72 × H36mm, W48 × H48mm, W72 × H72mm Counter/Timer

### ■ Features

- Selectable Counter or Timer function
- The most various function
- Prescale function
- Programmable count speed to 10kcps
- Batch counter function for CT6, CT6-2P only
- Selectable Voltage input (PNP) or No voltage input (NPN)
- Ability to set ON/OFF time individually in Flicker (FLK) mode
- Key Lock function



**⚠ Please read "Caution for your safety" in operation manual before using.**



### ■ Ordering information

<b>CT</b>	<b>6</b>	<b>S</b>	<b>-</b>	<b>2P</b>	
					I Indicator
					Single preset
					2P Double preset
					Y DIN Size W72×H36mm
					S DIN size W48×H48mm
					DIN size W72×H72mm
					4 9999(Digit)
					6 99999(Digit)
					CT Counter/Timer

※When using double preset type as timer mode, setting time is limited in one preset time.

### ■ Specifications

Model	Single preset	CT6Y	CT4S	CT6S	CT6	
	Double preset	CT6Y-2P	CT4S-2P	CT6S-2P	CT6-2P	
	Indicator	CT6Y-I	—	CT6S-I	CT6-I	
Digit		6	4	6	6	
Digit size		Counting part:W4.5×H10mm Setting part:W3.5×H7mm	Counting part:W7×H11mm Setting part:W5×H8mm	Counting part:W4.5×H10mm Setting part:W3.5×H7mm	Counting part:W7×H13mm Setting part:W5×H9mm	
Power supply	AC power	100-240VAC 50/60Hz				
	DC power	24-60VDC				
Allowable voltage range		90 ~ 110% of rated voltage(AC power)				
Power consumption	AC power	Indicator : Approx. 9VA, Single & Double preset : Approx. 10VA				
	DC power	Indicator & Single preset : Approx. 5W, Double preset : Approx. 6W				
Count speed of INA, INB		Selectable 1 / 30 / 1 / 5 / 10kcps				
Min. input signal width	Counter	Reset input : Selectable 1ms or 20ms				
	Timer	INA, INHIBIT, RESET : Selectable 1ms or 20ms			INA, RESET, INHIBIT, BATCH RESET (except CT6-I) : Selectable 1ms or 20ms	
Input		Selectable voltage input or No-voltage input [Voltage input] Input impedance : 5.4kΩ, "H" level : 5-30VDC, "L" level : 0-2VDC [No-voltage input] Short-circuit impedance : Max. 1kΩ, Residual voltage : Max. 2VDC, Open-circuit impedance : Min. 100kΩ				
One-shot output		10 / 50 / 100 / 200 / 500 / 1000 / 2000 / 5000ms				
Control output	Con-tact	Type	Single preset type : SPDT(1c) Double preset type : SPST(1a) for first output SPDT(1c) for second output	Single preset type : SPDT(1c), Double preset type : SPST(1a) for first/second output		
		Capacity	NO : 250VAC 3A at resistive load, NC : 250VAC 2A at resistive load			
	Solid-state	Type	Single preset type : 1 NPN open collector Double preset type : 1 NPN open collector			Single preset type : 2 NPN open collectors Double preset type : 3 NPN open collectors
		Capacity	Max. 30VDC, Max. 100mA			
Memory retention		10 years(When using non-volatile semiconductor memory)				
External sensor power		12VDC ±10%, Max. 100mA				

(A) Counter

(B) Timer

(C) Temp. controller

(D) Power controller

(E) Panel meter

(F) Tacho/Speed/Pulse meter

(G) Display unit

(H) Sensor controller

(I) Proximity sensor

(J) Photo electric sensor

(K) Pressure sensor

(L) Rotary encoder

(M) 5-Phase stepping motor & Driver & Controller

# CTY/CTS/CT Series

## Specifications

Time accuracy	Repeat error	Power ON start : Max. $\pm 0.01\% \pm 0.05\text{sec}$ Signal start : Max. $\pm 0.01\% \pm 0.03\text{sec}$			
	Set error				
	Voltage error				
	Temperature error				
Insulation resistance		Min. 100M $\Omega$ (at 500VDC)			
Dielectric strength		2000VAC 50/60Hz for 1 minute			
Noise strength		$\pm 2\text{kV}$ the square wave noise (pulse width:1 $\mu\text{s}$ ) by the noise simulator			
Vibration	Mechanical	0.75mm amplitude at frequency of 10 ~ 55Hz in each of X, Y, Z directions for 1 hour			
	Malfunction	0.5mm amplitude at frequency of 10 ~ 55Hz in each of X, Y, Z directions for 10 minutes			
Shock	Mechanical	300m/s <sup>2</sup> (Approx. 30G) in X,Y,Z directions for 3 times			
	Malfunction	100m/s <sup>2</sup> (Approx. 10G) in X,Y,Z directions for 3 times			
Relay life cycle	Mechanical	Min. 10,000,000 times			
	Electrical	Min. 100,000 times (NO : 250VAC 3A at resistive load, NC : 250VAC 2A at resistive load)			
Protection		IP65 (Front panel only)			
Ambient temperature		-10 ~ +55 $^{\circ}\text{C}$ (at non-freezing status)			
Storage temperature		-25 ~ +65 $^{\circ}\text{C}$ (at non-freezing status) $\square$			
Ambient humidity		35 ~ 85%RH			
Weight	AC power	CT6Y:Approx. 160g CT6Y-2P:Approx. 163g CT6Y-I:Approx. 127g	CT4S:Approx. 155g, CT4S-2P:Approx. 162g	CT6S:Approx. 155g CT6S-2P:Approx. 162g CT6S-I:Approx. 136g	CT6:Approx. 264g CT6-2P:Approx. 271g CT6-I:Approx. 244g
	DC power	CT6Y:Approx. 164g CT6Y-2P:Approx. 167g CT6Y-I:Approx. 130g	CT4S:Approx. 152g CT4S-2P:Approx. 159g	CT6S:Approx. 152g CT6S-2P:Approx. 159g CT6S-I:Approx. 133g	CT6:Approx. 263g CT6-2P:Approx. 270g CT6-I:Approx. 243g
Approval		CE C  US			

## Connections

### CT6Y

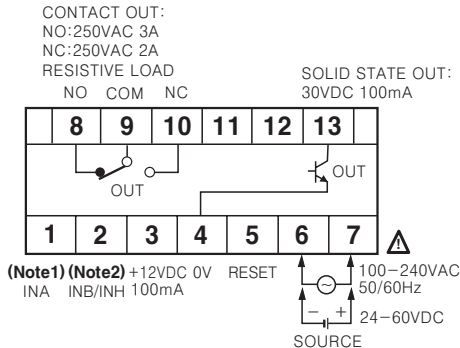

### CT6Y-2P

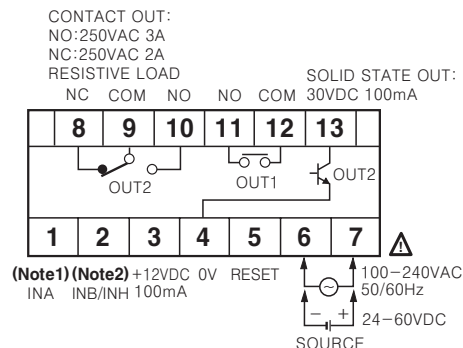

### CT6Y-I

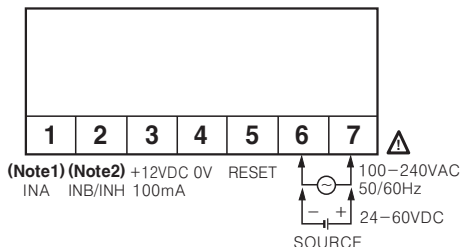

#### ※ (Note1) INA terminal

- Operation of Counter : Operating as INA signal or INH signal
- Operation of Timer : Operating as "START"

#### ※ (Note2) INB/INH terminal

- Operation of Counter : Operating as INB signal
- Operation of Timer : Operating as INH signal
- If the INH signal applied when it is used as Timer, the processing time stops. (Hold)

#### ※ Connection of relay contact input when voltage input (PNP) is selected

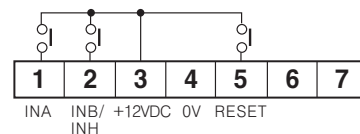

#### ※ Connection of relay contact input when No-voltage input (NPN) is selected

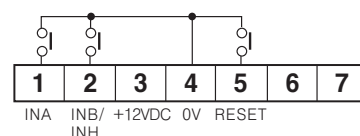

# Multi-Functional Counter/Timer

## ◎ CT4S, CT6S

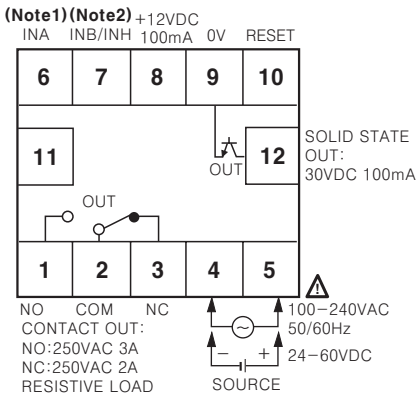

## ◎ CT4S-2P, CT6S-2P

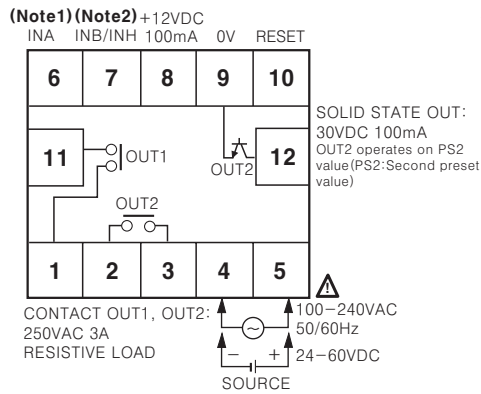

## ◎ CT6S-I

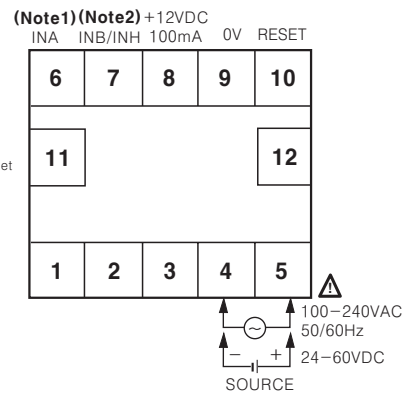

### (Note1)INA terminal

- Counter : It will be as input terminal of counting input or counting no input signal.
- Timer : It will be input terminal of START signal.

### (Note2)INB/INH terminal

- Operation of Counter : Operating as INB signal
- Operation of Timer : Operating as INH signal  
If the INH signal applied when it is used as Timer, the processing time stops.(Time Hold)

- Connection of relay contact input when voltage input(PNP) is selected

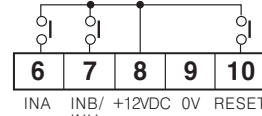

- Connection of relay contact input when No-voltage input(NPN) is selected

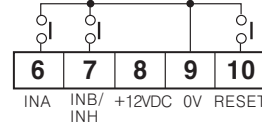

## ◎ CT6

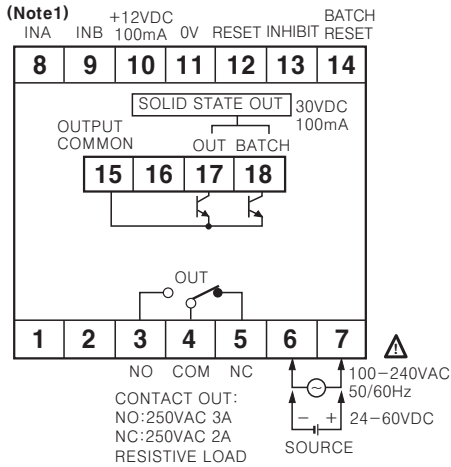

## ◎ CT6-2P

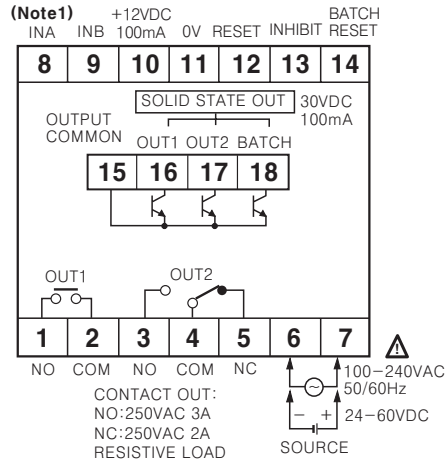

## ◎ CT6-I

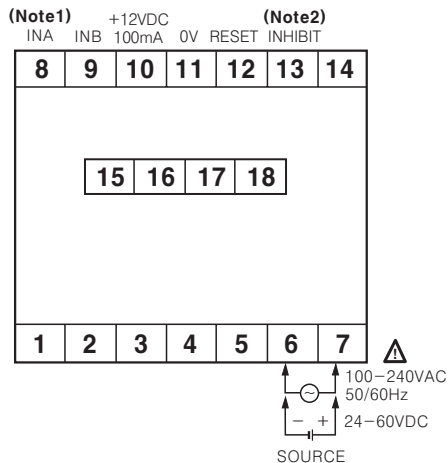

### ※(Note1)INA terminal

- Counter : It will be as input terminal of counting input or counting no input signal.
- Timer : It will be input terminal of START signal.

### ※(Note2)INHIBIT signal

- When INHIBIT is applied at Timer operation:Processing time stops
- ※Solid state output is insulated from inner circuit by photocoupler. (Time Hold) (Power supply : 5-30VDC Max.)

- Connection of contact input in state of selected voltage input(PNP)

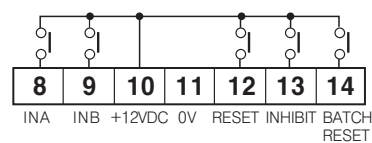

- Connection of contact input in state of selected No-voltage input

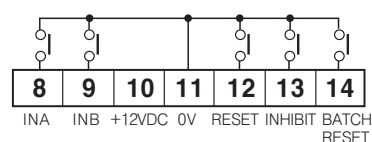

(A)  
Counter

(B)  
Timer

(C)  
Temp.  
controller

(D)  
Power  
controller

(E)  
Panel  
meter

(F)  
Tacho/  
Speed/  
Pulse  
meter

(G)  
Display  
unit

(H)  
Sensor  
controller

(I)  
Proximity  
sensor

(J)  
Photo  
electric  
sensor

(K)  
Pressure  
sensor

(L)  
Rotary  
encoder

(M)  
5-Phase  
stepping  
motor &  
Driver &  
Controller

# CTY/CTS/CT Series

## ▣ Dimensions

### ○ CTY Series

#### ● CT6Y

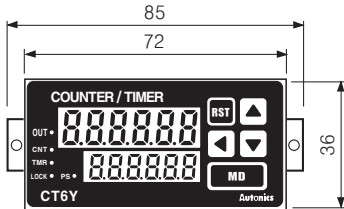
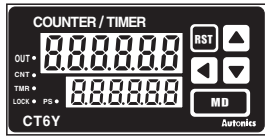

#### ● CT6Y-2P

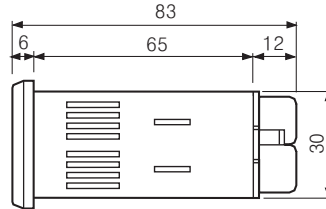
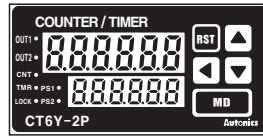

#### ● CT6Y-I

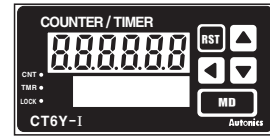

#### ● Panel cut-out

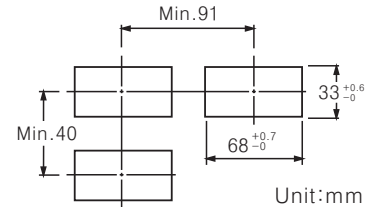

Unit:mm

### ○ CTS Series

#### ● CT4S

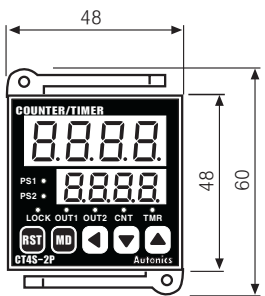

#### ● CT4S-2P

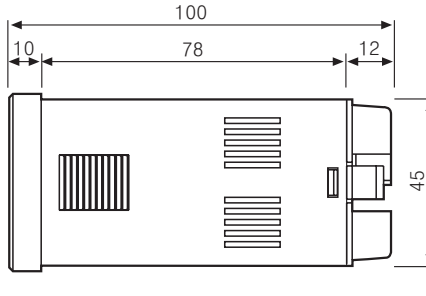

#### ● CT6S



#### ● CT6S-2P



#### ● CT6S-I



#### ● Panel cut-out

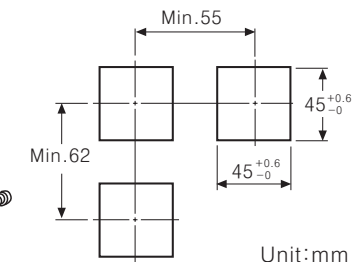

Unit:mm

### ○ CT Series

#### ● CT6

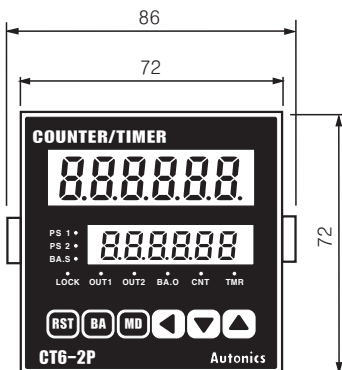

#### ● CT6-2P

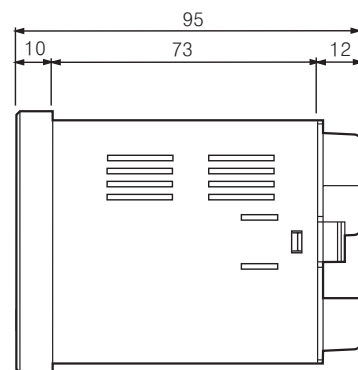
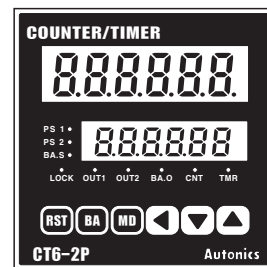

#### ● CT6-I

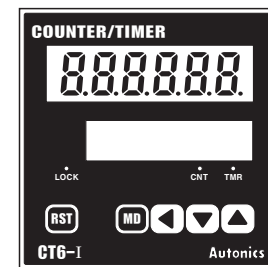

#### ● Panel cut-out

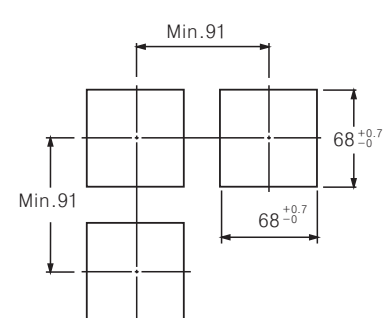

Unit:mm

# Multi-Functional Counter/Timer

## Front panel identification

◎ CTY series

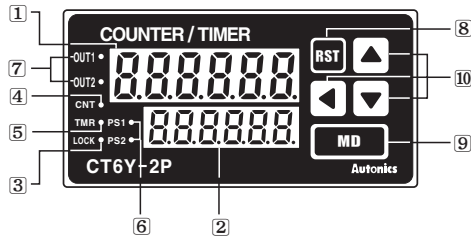

- 1 Display for processing value (Red LED)  
Counting value (Counter) / Processing time (Timer) / Setting symbols  
LED height : 11mm for 4digit, 10mm for 6digit
- 2 Preset value display (Yellow-Green LED)  
Preset value (Counter) / Preset time (Timer) and setting symbols.  
LED height : 8mm for 4digit, 7mm for 6digit
- 3 LOCK : Key Lock indication  
LOCK OFF : Light OFF  
LOCK ON : Light ON
- 4 CNT : Indicates operation as a counter

※ There is no 6, 7 LED in CT6Y-I, CT6S-I.

※ In CT4S, CT6S, CT6Y, PS2 will be changed to PS and OUT2 is OUT and there is no PS1, OUT1 LED.

◎ CTS series

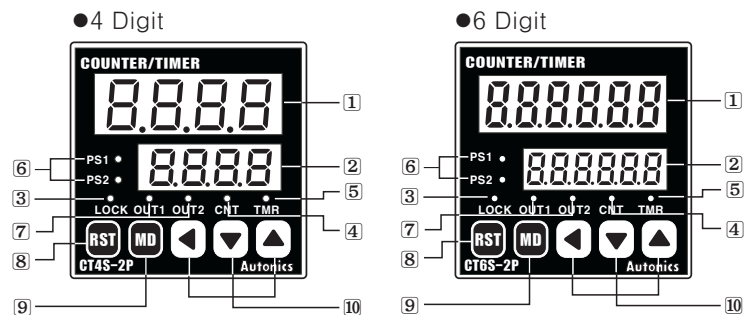

- 5 TMR : Indicates operation as a timer  
-LED flickers when the timer is processing  
-LED turns on when the processing time stops
- 6 PS1, PS2 : Indicates that preset is being displayed or changed.
- 7 OUT1, OUT2 : Indicating the operation of output
- 8 RST : Reset key
- 9 MD : Mode key
- 10 ◀, ▼, ▲ : Set key

◎ CT Series

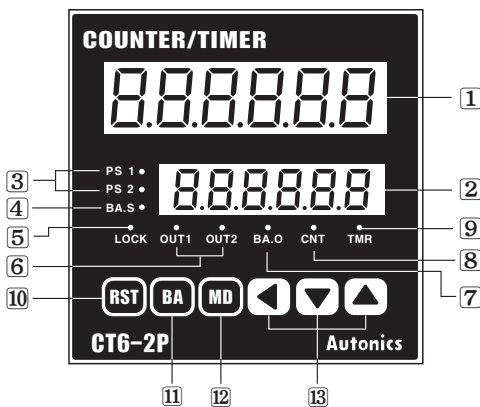

- 1 Display for processing value (Red LED)  
Counting value (Counter) / Processing time (Timer) / Setting symbols  
LED height : 13mm
- 2 Preset value display (Yellow-Green LED)  
Preset value (Counter) / Preset time (Timer) and setting symbols  
LED height : 9mm
- 3 PS1, PS2 : Indicates which preset is being displayed or changed
- 4 BA.S : Indicates a batch value has been preset
- 5 LOCK : Key lock display
- 6 OUT1, OUT2 : Preset the operation of output (Single & Double)
- 7 BA.O : Indication the operation of BATCH output
- 8 CNT : Indication the operation of counter
- 9 TMR : Indication the operation of timer  
-LED flickers when the timer is operating  
-LED turns off when the operating time stops
- 10 RST : Reset key
- 11 BA : Batch key
- 12 MD : Mode key
- 13 ◀, ▼, ▲ : Set key

※ In CT6, PS2 will be changed to PS and OUT2 to OUT, since there is no PS1, OUT1 LED.

※ There is no PS1, PS2, BA.S, OUT1, OUT2, BA.O LED in CT6-I.

※ There are no BA key in CT6-I.

(A)  
Counter

(B)  
Timer

(C)  
Temp. controller

(D)  
Power controller

(E)  
Panel meter

(F)  
Tacho/  
Speed/  
Pulse meter

(G)  
Display unit

(H)  
Sensor controller

(I)  
Proximity sensor

(J)  
Photo electric sensor

(K)  
Pressure sensor

(L)  
Rotary encoder

(M)  
5-Phase stepping motor & Driver & Controller

# CTY/CTS/CT Series

## Input connections

### Input logic : No-voltage input(NPN)

●Solid state input(Standard sensor : NPN output type sensor)

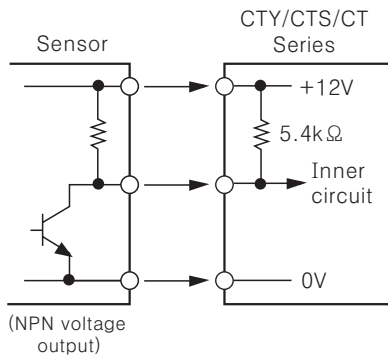

(NPN voltage output)

※INPUT circuit of INA, INB, INH(INHIBIT), BATCH RESET, RESET are the same.

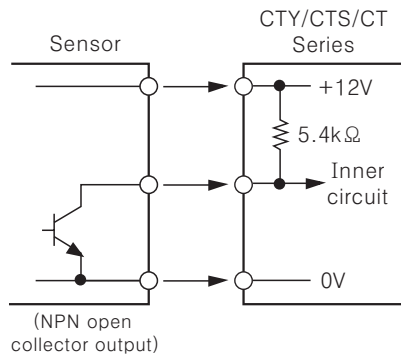

(NPN open collector output)

●Contact input

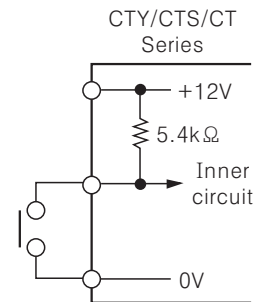

※Counting speed:  
1 or 30cps setting  
(Counter)

### Input logic : Voltage input(PNP)

●Solid state input(Standard sensor : PNP output type sensor)

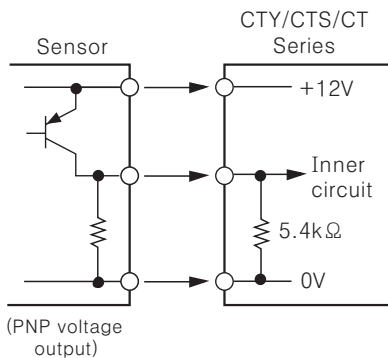

(PNP voltage output)

※INPUT circuit of INA, INB, INH(INHIBIT), BATCH RESET, RESET are the same.  
※INA is input terminal when it is used for Counter and can be START signal input terminal when it used for Timer.

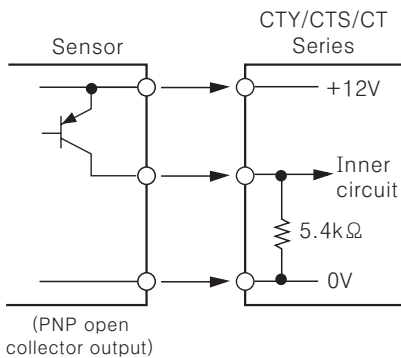

(PNP open collector output)

●Contact input

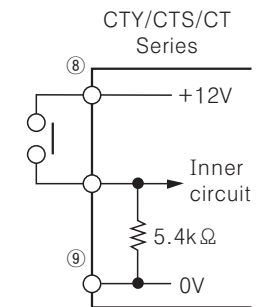

※Counting speed:  
1 or 30cps setting  
(Counter)

## Input logic selection

### CTY/CTS Series

1. The power must be cut off.
2. Detach the case from body.

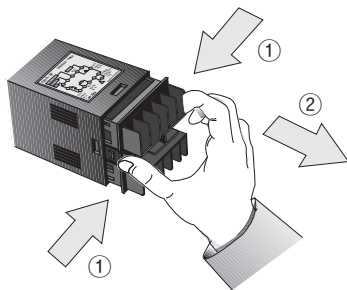

\*Case detachment  
Squeeze toward ① and pull toward ② as shown in picture.

**\*\* Please check if the power is cut off!! \*\***

3. Select input logic by using input logic S/W inside Counter/Timer.

●Select No-voltage input(NPN)      ●Select voltage input(PNP)

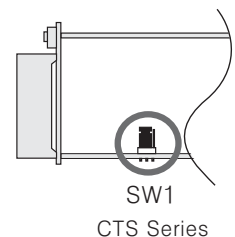
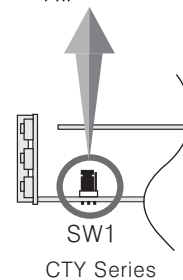
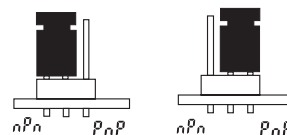

4. Please assemble opposite way of the case detachment.
5. Then apply the power to Counter/Timer.

# Multi-Functional Counter/Timer

## ◎CT Series

It is easy to change input logic by S/W for input logic conversion.

- Select PNP(Voltage input)
- Select NPN(No-Voltage input)

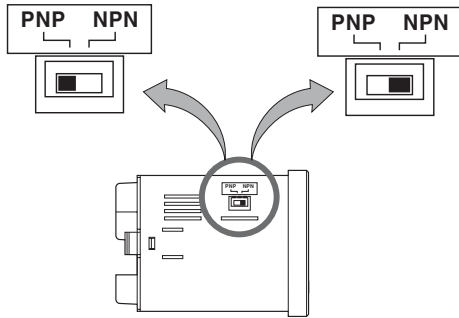

## ■ Output connections

### ◎Contact output

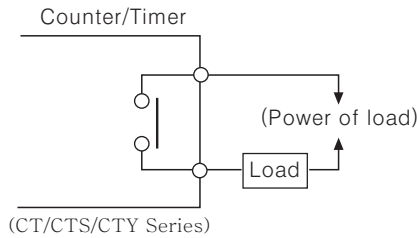

- \*Relay contact is 250VAC 3A Max.
- \*Use proper load not to exceed relay contact.

### ◎Solid state output

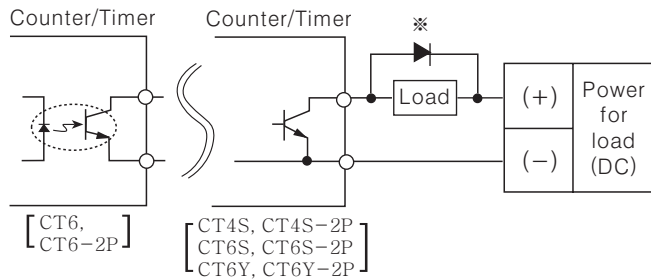

- \*When using inductive load(Relay etc), surge absorber(Diode, Varistor etc.) must be connected across the load.
- \*Use proper load and power for load not to exceed ON/OFF capacity(30VDC Max. 100mA max.) of solid state output.
- \*Be sure not to apply reverse polarity of power.

## ■ Factory Default settings

Set item		Model			
		CT6-2P CT6S-2P CT4S-2P CT6Y-2P	CT6 CT6S CT4S CT6Y	CT6-I CT6S-I CT6Y-I	
COUNTER	Input mode	Up/Down-C(U/D-C)			
	Output mode	F			
	OUT1	100ms			
	OUT2(OUT)	Hold			
	CPS	30cps			
	Min. reset time	20ms			
	Decimal point	No decimal point			
	Prescale value	6digit : 1.000, 4digit : 1.00			
Counting memory	CLEr(Power reset)				
TIMER	Time range	6digit : 0.01s ~ 9999.99s 4digit : 0.01s ~ 99.99s			
	Up/Down mode	U(UP)			
	Output mode	OND(ON Delay)			
	Output time	Hold			
	Input signal mode	20ms			
Input method	No-voltage input(NPN)				
Lock key	L.oFF(Lock OFF)				
Counter / Timer	Counter				

## ■ Error code display

Error display	Errors	Output status	How to return
Err 1	CPU error	OFF	rst key, RESET input

(A)  
Counter

(B)  
Timer

(C)  
Temp.  
controller

(D)  
Power  
controller

(E)  
Panel  
meter

(F)  
Tacho/  
Speed/  
Pulse  
meter

(G)  
Display  
unit

(H)  
Sensor  
controller

(I)  
Proximity  
sensor

(J)  
Photo  
electric  
sensor

(K)  
Pressure  
sensor

(L)  
Rotary  
encoder

(M)  
5-Phase  
stepping  
motor &  
Driver &  
Controller

# CTY/CTS/CT Series

## Counter mode

### Operation mode in Counter

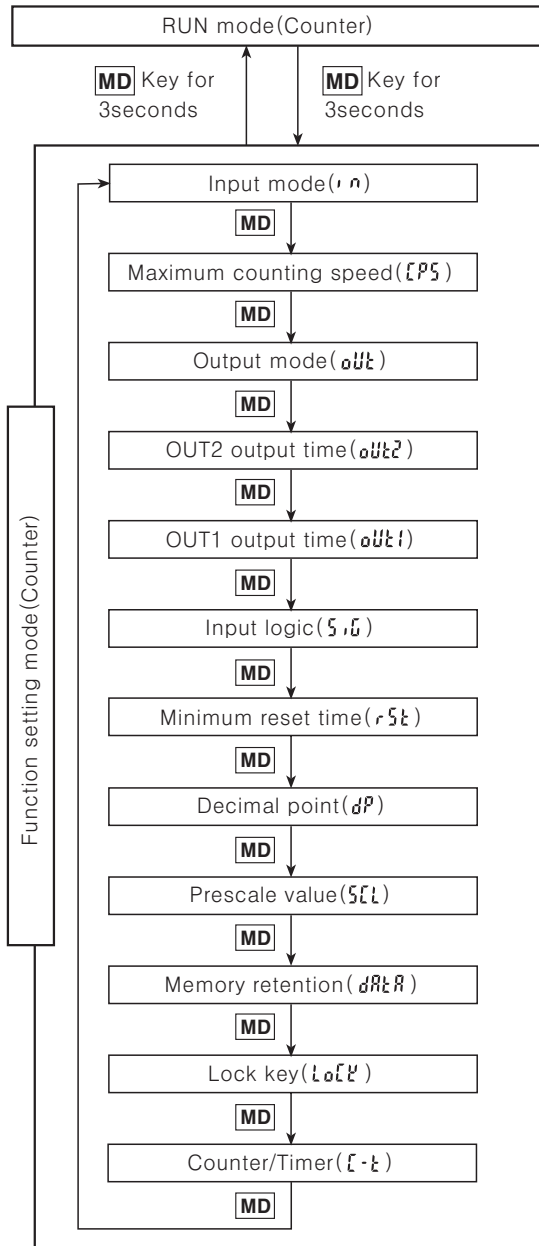

- Pressing **MD** for over 3sec., it will enter into Counter function setting mode.
- Pressing **MD** for over 3sec., it will return to Counter RUN mode.
- If no keys are touched for over 60sec., it will return to Counter RUN mode.
- When using this is unit as a counter, please change to Timer (**T**) in Counter/Timer setting. Then press **MD** for over 3sec. to move to counter RUN mode and change the setting value. (See A-23page for the specific description of Timer.)

## Change of preset value in Counter operation

### Change the preset value in the single preset type(CT6)

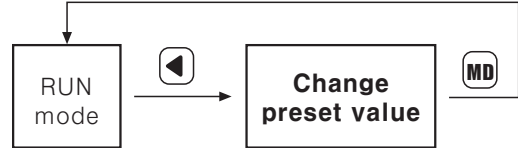

### Change the preset value in the double preset type(CT6Y-2P)

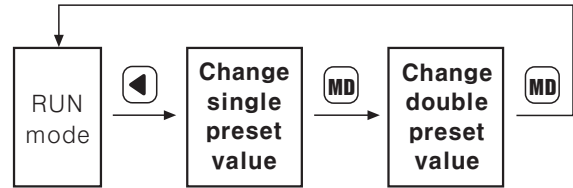

※ While changing preset value, input counter signals are still accepted.

When changing preset value, if no key is touched for 60 sec., the counter will return to RUN mode.

After changing the preset value as "0", there is **RST** key input or RESET input at RUN mode, the output will be maintained as OFF. (But in state of the output mode is "T", if changing single preset value as "0", the single output will be maintained as ON.)

### Change of Batch preset value Batch counter function is only available in CT6, CT6-2P type.

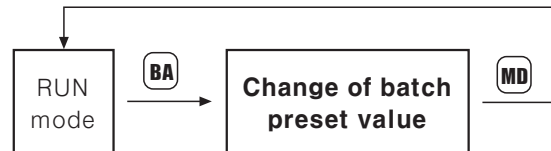

- If you press **BA** key in RUN mode, it will allow you to make change to the batch preset value. After changing the batch preset value using same method as the method of Counter preset value changes by **←**, **↓**, **↑** keys, it will return to RUN mode by pressing **MD** key. When proceeding to change the batch preset value, the current batch counting value is also displayed.

## How to set Lock key

Be sure to set the lock mode in order to protect against accidental or unauthorized key operation.

**LoL0** (LOCK OFF) : Cancellation of the lock mode

**LoL1** (LOCK LEVEL 1) : Lock **RST** key

**LoL2** (LOCK LEVEL 2) : Lock **←** & **↓** & **↑** key

**LoL3** (LOCK LEVEL 3) : Lock **RST** & **←** & **↓** & **↑** key



# Multi-Functional Counter/Timer

## Setting of Counter function modes

(**MD** key : Use the **▲** or **▼** key to change the setting)

Setting mode	How to set(▲, ▼)	
Input mode (i n)	→ U → d → Ud-A → Ud-b → Ud-C	※When "U" or "d" of input mode is set, "S, t, d" of output mode will not be displayed.
Maximum counting speed (CP5)	→ 1 → 30 → 1K → 5K → 10K	※Counting speed is determined by one by one(1:1) duty ratio of INA or INB input signal, and it is applied to both INA or INB. ※When using setting "d" in output mode, 5kcps and 10kcps are not indicated in the display.
Output mode (oUt)	<ul style="list-style-type: none"> <li>●Up or Down input mode → F → n → C → r → K → P → Q → R</li> <li>●Up/Down-A, B, C input mode → F → n → C → r → K → P → Q → R → S → t → d</li> </ul>	※When setting output mode as "F, n", if counting value reaches the preset value, output will be held. So there is no "OUT2 output time" in function setting mode. ※If the maximum counting speed is 5kcps or 10kcps, when you change output mode to "d", the maximum counting speed will be changed to 1cps.
OUT2 output time(oUt2)	→ 10 → 50 → 100 → 200 → 500 → 1000 → 2000 → 5000 Unit:ms	※There is no "OUT1 output time" in single preset model, "OUT2 output time" will be shown as "OUT output time(oUt t)".
OUT1 output time(oUt1)	→ 10 → 50 → 100 → 200 → 500 → 1000 → 2000 → 5000 → Hold Unit:ms	
Input logic (S, t)	nPn : Voltage input    PnP : No-voltage input	※It indicates according to internal position, and it can't be set by ▲ & ▼ key.
Min. reset time (rSt)	1 ↔ 20    Unit:ms	※Min. external RESET signal width
Decimal point (dP)	<ul style="list-style-type: none"> <li>● 6 Digit → ..... * → ..... * → ..... *</li> <li>● 4 Digit → ..... * → ..... *</li> </ul>	※Decimal point setting is applied to counting value and setting value at the same.
Prescale value (SEL)	※ <b>MD</b> key : Shift the flickering digit ※ <b>▲</b> , <b>▼</b> key : Change the prescale value ※Prescale value : It is actual value of length and position, liquid measure from counting input of 1pulse.	※Set range of prescale value 6Digit : 0.001 ~ 99.999 4Digit : 0.01 ~ 9.99
Memory retention (dRtR)	CLEr ↔ rEE	※CLEr : Power reset for counting value. (Reset counting value when power off) rEE : Memorize counting value (Memorize counting value when power off)
Lock key (LoLk)	→ L.off → LoL.1 → LoL.2 → LoL.3	
Counter/Timer (C-t)	CoUn ↔ t, nE	※CoUn : Counter t, nE : Timer

- (A) Counter
- (B) Timer
- (C) Temp. controller
- (D) Power controller
- (E) Panel meter
- (F) Tacho/Speed/Pulse meter
- (G) Display unit
- (H) Sensor controller
- (I) Proximity sensor
- (J) Photo electric sensor
- (K) Pressure sensor
- (L) Rotary encoder
- (M) 5-Phase stepping motor & Driver & Controller

※When selecting the "d" output mode and if 1kcps is used, the output may not operate normally because of response time of the contact. Therefore, in this case be sure to use the solid state output.  
 ※When it is in function setting mode, no external input signal will be accepted and the output will stay in the OFF state.  
 ※There are no output mode and output time setting mode(OUT1, OUT2) of function setting mode in CT6Y-I, CT6S-I, CT6-I models.

# CTY/CTS/CT Series

## Change of Counter preset value

### Change the set preset value of single preset type(CT6)

How to change in the single preset type : To change the preset value from **175 to 180**.

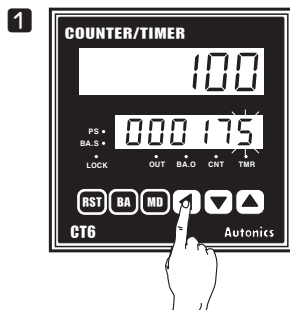

Press key to enter in state of changing preset value. The prior preset value is indicated and the first digit "5" flashes. (PS LED ON)

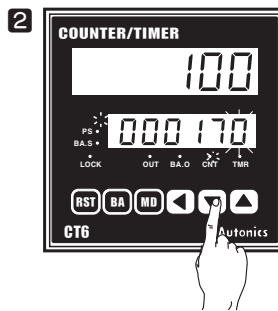

Change "5" to "0" by pressing key 5 times, and shift the flickering to the second digit by key once.

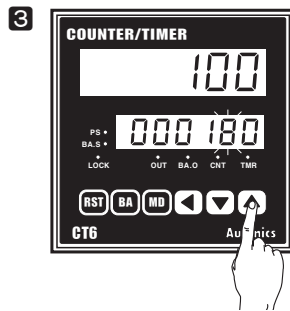

Change "7" to "8" by pressing key once.

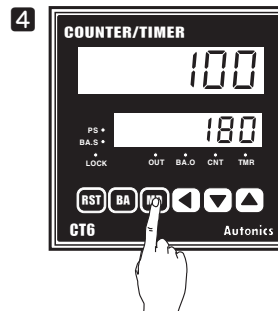

The change to the preset value is completed. To return to RUN mode, press key. (PS LED OFF)

### Change the preset value of double preset type(CT6-2P)

How to change in the double preset type : To change the double preset value from **500 to 1000** when the single preset value is **250** and the double preset value is 500.

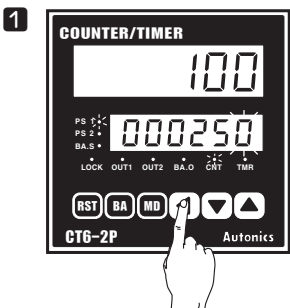

Pressing key, it will enter into the change of single preset. The previous setting value will be displayed and "0" will flickers. (PS1 LED ON, PS2 LED OFF)

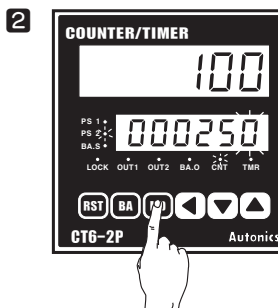

The single preset value is not changed. Move to the change of double preset value by pressing key. The previous double preset value "500" is displayed and the "0" will flicker. (PS1 LED OFF, PS2 LED OFF)

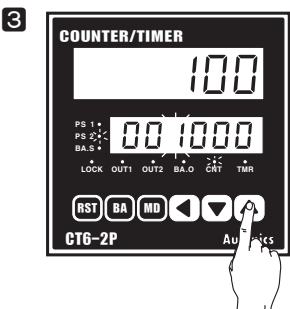

Change "500" to "1000" with , , . (The change method is the same as Single preset type Counter)

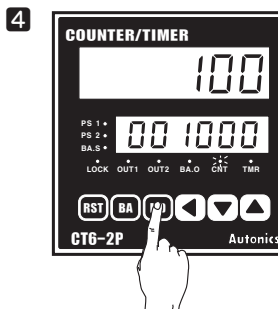

Press key to complete the setting and return to RUN mode. (PS1 LED OFF, PS2 LED ON)

※When changing preset value, if no key is touched for 60 sec., the counter will return to RUN mode.

※After changing the preset value to "0", if key input or RESET input is applied at RUN mode, the output will be maintained as OFF. (But if state of the output mode is "T", when single preset value is set to "0", the single output will be maintained as ON.)

※Whenever key is pressed in the state of changing preset value, the flickering digit shifts from the right to the left.



# Multi-Functional Counter/Timer

## Batch Counter function(Counter)

### Change the setting value of Batch counter

● In case of setting Batch setting value as "50"

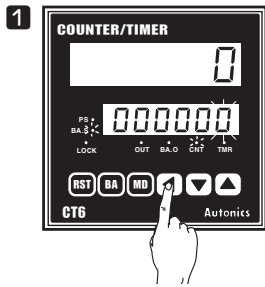

1 Press **BA** key in RUN mode, it will enter into the program state of Batch setting value. (BA.S LED ON display)  
After entering into the state of setting the first "0" will flicker and the remaining digits will be on steady.

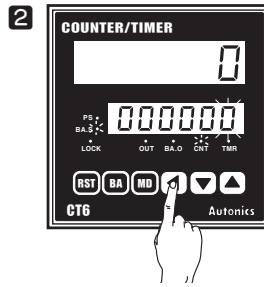

2 Move to the second position by pressing **←** key one time. The second "0" will flicker.

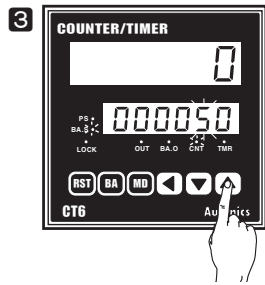

3 Change "0" to "5" by pressing **▲** 5times.

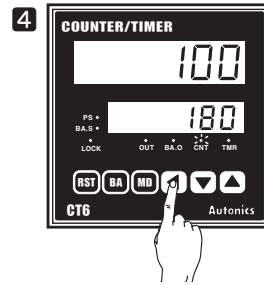

4 Pressing **MD** key to complete the Batch setting will return Counter to the RUN mode. (BA.S LED OFF display)

※ Batch Counter function is only in CT6 and CT6-2P.

※ When entering into Batch setting, if no key is touched for 60sec., it will return to Counter operation mode.

### Batch Counter function

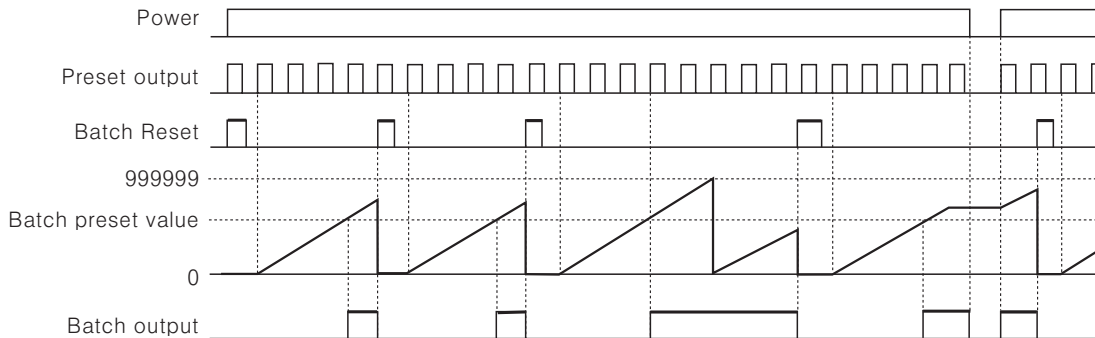

※ When the Batch counting value reaches to the Batch set value, the Batch count value is continuously increased and the Batch output remains in the ON state until the Batch reset is applied.

※ When the Batch output turns on and if the power turns off and then turns on again, the Batch output remains in the ON state until the Batch reset signal is applied.

※ When the Batch counting value counts over 999999, it resets to "0", and it counts up again.

※ If the Batch set value is "0(ZERO)", the Batch counting value counts up, but output remains in the OFF state.

※ The Batch counting value is not changed by front **RST** key or external reset signal.

※ In the CT6-2P, "Count-up" refers to reacting the second set value.

### Reset the Batch counting value

When the terminal of Batch RESET is externally short-circuited, the BATCH counting value will be reset. But the Batch RESET is different dependent on the input logic setting.

: When Voltage input type(PNP) is selected, please make terminal numbers **10** and **14** short-circuited.

And when No-voltage input type(NPN) is selected, please make terminal number of **11** and **14** short-circuited.

### Check the Batch counting value

In order to check the Batch counting value during the Counter operation, press the **BA** key to display both the Batch counting value and setting value.

After checking Batch counting value, it will return to RUN mode by pressing **MD** key.

※ There is no **BA** key lock function for Batch function.

(A)  
Counter

(B)  
Timer

(C)  
Temp.  
controller

(D)  
Power  
controller

(E)  
Panel  
meter

(F)  
Tacho/  
Speed/  
Pulse  
meter

(G)  
Display  
unit

(H)  
Sensor  
controller

(I)  
Proximity  
sensor

(J)  
Photo  
electric  
sensor

(K)  
Pressure  
sensor

(L)  
Rotary  
encoder

(M)  
5-Phase  
stepping  
motor &  
Driver &  
Controller

# CTY/CTS/CT Series

## Input operation mode for counter

Input mode	Counting chart	Notice
<b>U</b> (UP)		※ INA : Counting input ※ INB : Inhibit input (Limit counting input of INA) ※ When INB changes from L to H, up count signals on INA will not be accepted.
		※ INA : Inhibit input (Limit counting input of INB) ※ INB : Counting input ※ When INA changes from H to L, up count signals on INB will not be accepted.
<b>d</b> (DOWN)		※ INA : Counting input ※ INB : Inhibit input (Limit counting input of INA) ※ When INB changes from L to H, down count signals on INA will not be accepted. ※ n=Preset value
		※ INB : Counting value input ※ INA : Inhibit input (Limit counting input of INB) ※ n=Preset value ※ When INA changes H to L, down count signals on INB will not be accepted.
<b>Ud-A</b> (Up/Down-A) Command input		※ INA : Counting input ※ INB : Command input for Up/Down counting ※ When INB is L, count increases. When INB is H, count decreases.
<b>Ud-b</b> (Up/Down-B) Individual input		※ INA : Up count input ※ INB : Down count input ※ When INA and INB are applied L to H at same time, the count remains unchanged.
<b>Ud-C</b> (Up/Down-C) Phase difference input		※ When using A, B phase of encoder and connecting to INA, INB, Please set counter input mode (Ud-C) as phase difference input (Ud-C).

※ Ⓐ : Over Min. signal width, Ⓑ : Over 1/2 of Min. signal width.

Counting miss by one(±) is occurred if the signal width of Ⓐ or Ⓑ is less than Min. signal width.

※ "H" and "L"

	Voltage input (PNP)	Contact input (NPN)
H	5-30VDC	Short circuit
L	0-2VDC	Open

※ Min. signal width by counting speed

Counting speed	Min. signal width
1cps	500ms
30cps	16.7ms
1kcps	0.5ms
5kcps	0.1ms
10kcps	0.05ms

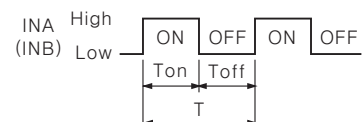

※ Ton, Toff : Min. signal width

# Multi-Functional Counter/Timer

## Application of Prescale function

This function is to set and indicate calculated unit for actual length, liquid measure, position, etc. It is called "Prescale value" for measured length, measured liquid, measured position per 1 pulse.

Ex1) Counting control by Counter(CT6) and Limit Switch

: As below application, when the cutter operates 1 time, 10 sheets of paper are produced. In this case, if we set 10 as prescale setting value of function mode, Counter indicates 10, 20, 30.....whenever limit switch operates 1st time, 2nd time, 3rd time....(no need to set decimal point)

Ex2) Length control by Counter(CT6) and Encoder

: In case of cutting paper each 300mm using a 50mm diameter (D) roller connected with Encoder of 1000 pulse.

- Set decimal point 3 digit at decimal set mode of function set mode. Set 0.157 of prescale value at prescale value set mode.
- If set preset value 300.000 at RUN mode, Counter will count each 0.157 per 1 input signal.

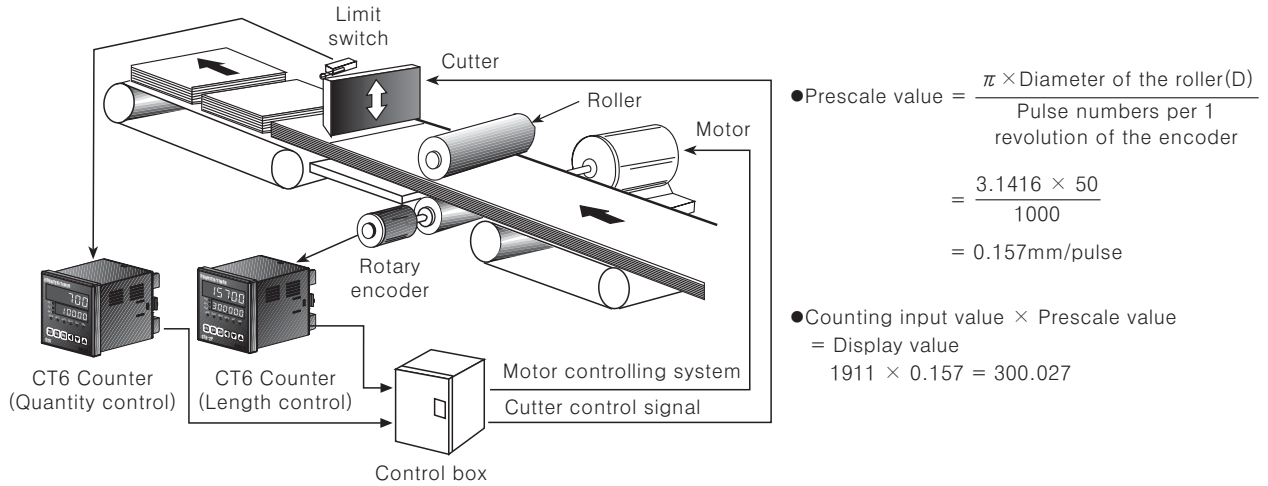

## Application of Batch Counter function

◎ Put 5 pieces of product in a box then pack the boxes together when the number of boxes reaches to 200 pieces.

- Counter preset value : PRESET value (setting value) = "5", Batch setting value = "200"
  - When the counting value of Counter reaches to the preset value "5", the counting value of Batch Counter will be increased by "1" and the control output (OUT) will be on. When the control box receives the control output (OUT), it moves the conveyor so the next empty box can be filled.
- When the counting value of Batch reaches to "200", Batch output will be ON.  
 Then the control box stops conveyor and provides a control signal for packing.

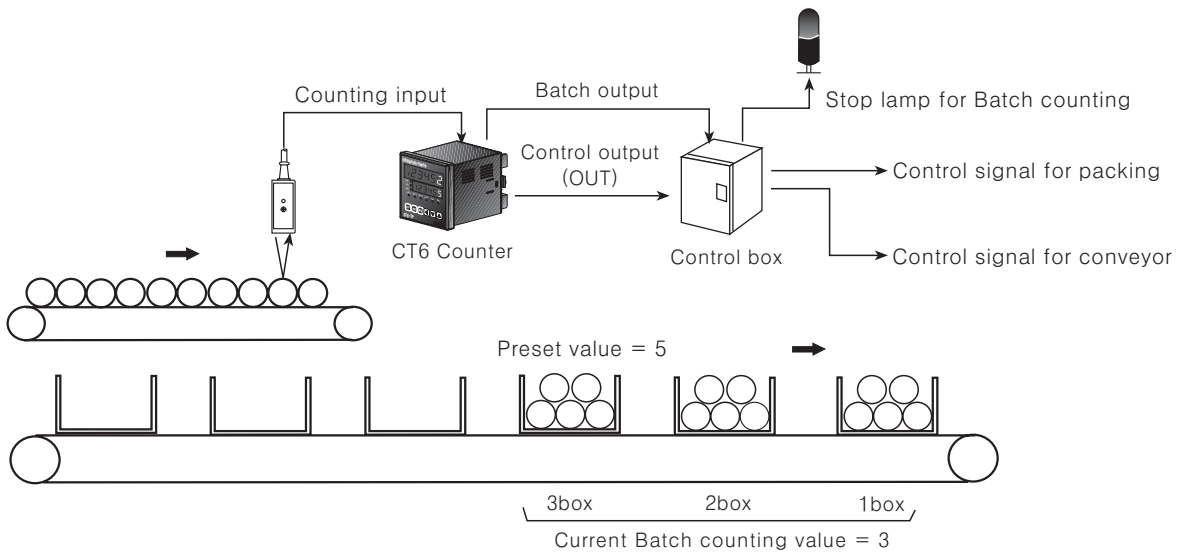

(A) Counter

(B) Timer

(C) Temp. controller

(D) Power controller

(E) Panel meter

(F) Tacho/Speed/Pulse meter

(G) Display unit

(H) Sensor controller

(I) Proximity sensor

(J) Photo electric sensor

(K) Pressure sensor

(L) Rotary encoder

(M) 5-Phase stepping motor & Driver & Controller

# CTY/CTS/CT Series

## Output operation mode(Counter)

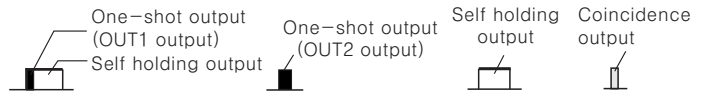

Output mode	Input mode			Operation
	Up	Down	Up/Down A, B, C	
<b>F (F)</b>				<ul style="list-style-type: none"> <li>After Counting up, the display value increases or decreases until the reset signal is applied, and hold outputs will be held.</li> </ul>
<b>N (N)</b>				<ul style="list-style-type: none"> <li>After counting up, display value and hold output will be held until reset signal is applied.</li> </ul>
<b>C (C)</b>				<ul style="list-style-type: none"> <li>The display value will be Reset Start at the same time counting up.</li> <li>The hold output of OUT1 turns off after one-shot time of OUT2.</li> <li>The one-shot output of OUT1 operates regardless to OUT2.</li> </ul>
<b>R (R)</b>				<ul style="list-style-type: none"> <li>After one shot Time of OUT2, display value will be Reset start counting operation starts again.</li> <li>The hold output of OUT1 turns off after one-shot time of OUT2.</li> <li>The one-shot output of OUT1 operates regardless to OUT2.</li> </ul>
<b>K (K)</b>				<ul style="list-style-type: none"> <li>After counting up, the display value increases or decreases until the reset signal is applied.</li> <li>The hold output of OUT1 turns off after one-shot time of OUT2.</li> <li>The one-shot output of OUT1 operates regardless to OUT2.</li> </ul>
<b>P (P)</b>				<ul style="list-style-type: none"> <li>After counting up, display value is held for the one-shot time of OUT2, Counter operation starts again at the same time of OUT2 output is ON and count value will be Reset start.</li> <li>The hold output of OUT1 turns off after one-shot time of OUT2.</li> <li>The one-shot output of OUT1 operates regardless to OUT2.</li> </ul>
<b>Q (Q)</b>				<ul style="list-style-type: none"> <li>After counting up, display value increases or decreases for the one-shot time of OUT2.</li> <li>The hold output of OUT1 turns off after one-shot time of OUT2.</li> <li>The one-shot output of OUT1 operates regardless to OUT2.</li> </ul>
<b>A (A)</b>				<ul style="list-style-type: none"> <li>After counting up, display value and the hold output of OUT1 is held until applying the reset signal.</li> <li>The one-shot output of OUT1 operates regardless to OUT2.</li> <li>OUT2 returns automatically after one shot time.</li> </ul>

※The output of single preset type is operating the same as OUT2 of double preset type.

# Multi-Functional Counter/Timer

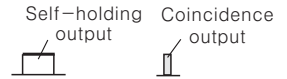

Output mode	Up/Down – A, B, C	Operation
$\Sigma$ (S)		※OUT1 and OUT2 keeps ON state in following condition ; Display value $\geq$ Preset 1 Display value $\geq$ Preset 2
$\Sigma$ (T)		※OUT1 keeps OFF state when display value is smaller than Preset 1 value, but if Preset 2 is "0", OUT1 keeps ON state. ※OUT2 keeps ON state when display value is equal or larger than Preset 2.
$\Delta$ (D)		※When display value is equal to set value(Preset 1, Preset 2) only, OUT1 or OUT2 output keeps ON state. ※When set 1kcps for counting speed, solid state contact output should be used.

※The output of single preset operates of double preset type.

## Counter operation of Indication model(CT6Y-I, CT6S-I, CT6-I)

●In case of input mode is Up( $\Sigma$ )

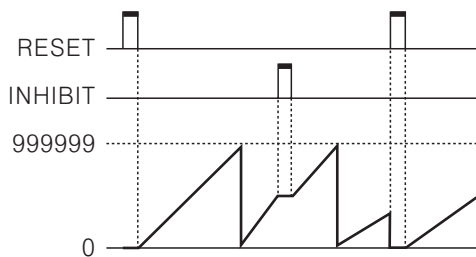

●In case of input mode is Down( $\Delta$ )

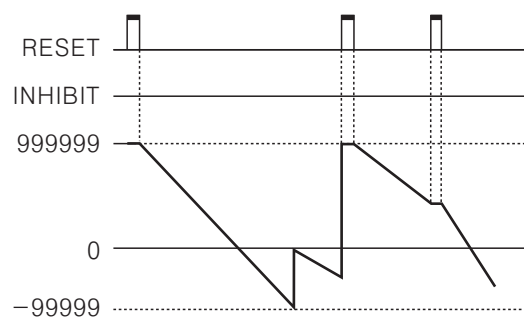

●In case of the input mode is command input( $\Delta d-R$ ), Individual input( $\Delta d-b$ ), Phase difference input( $\Delta d-t$ )

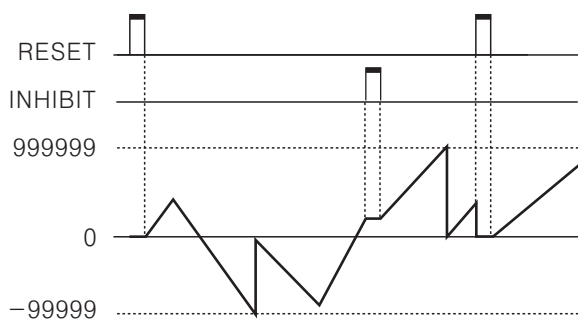

(A) Counter

(B) Timer

(C) Temp. controller

(D) Power controller

(E) Panel meter

(F) Tacho/Speed/Pulse meter

(G) Display unit

(H) Sensor controller

(I) Proximity sensor

(J) Photo electric sensor

(K) Pressure sensor

(L) Rotary encoder

(M) 5-Phase stepping motor & Driver & Controller

# CTY/CTS/CT Series

## ■ Timer mode

### ○ Operation mode in Timer

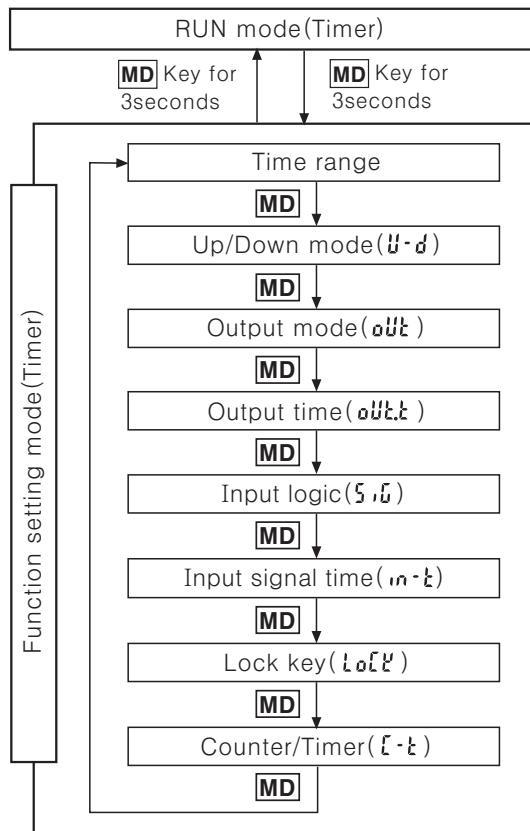

- Pressing **MD** for over 3sec., it will enter into Timer function setting mode
- Pressing **MD** for over 3sec., it will return to Timer RUN mode.
- When using this unit as a Timer, please change to Timer (t) in Counter/Timer setting. Then press **MD** for over 3sec. to move to Timer RUN mode and change the setting value.
- If no keys are touched for over 60sec., it will return to Timer RUN mode.

## ■ Change of preset value in Timer operation

### ○ To change preset time in case of the output is not FLK

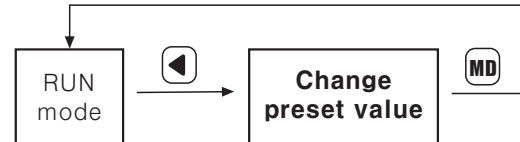

- In state of changing preset value, if no key is touched for 60sec., the timer will return to RUN mode.

### ○ To change preset time in case of the output is FLK

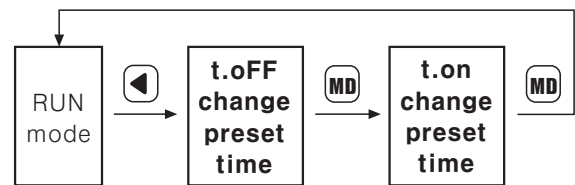

- In state of changing preset value, if no key is touched for 60sec., the timer will return to RUN mode.

### ○ Change of Batch preset value

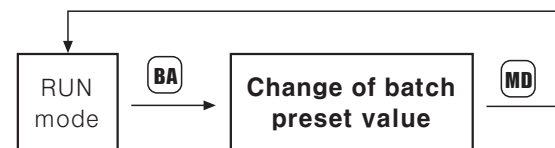

- If press **BA** key at RUN mode, it will move to the state of batch preset value changes. After change the batch preset value same as the method of Counter preset value changes by **←**, **↓**, **↑** keys, it will move to RUN mode by pressing **MD** key. When it moves to the state of batch preset value, the previous batch counting value will be displayed.

## ■ Time range

### 1) 6 Digit type Time range

Time range	Function setting mode	
	Timing display	Preset display
0.01s to 9999.99s	SEC	999999
0.1s to 99999.9s	SEC	999999
1s to 999999s	SEC	999999
0.01s to 99m 59.99s	h S	995999
0.1s to 999m 59.9s	h S	999599
0.1m to 99999.9m	h	999999
1m to 999999m	h	999999
1s to 99h 59m 59s	H h S	995959
1m to 9999h 59m	H h	999959

※ Model : CT6Y-2P, CT6Y, CT6Y-I, CT6S-2P, CT6S, CT6S-I, CT6-2P, CT6, CT6-I

### 2) 4 Digit type Time range

Time range	Function setting mode	
	Timing display	Preset display
0.01s to 99.99s	SEC	9999
0.1s to 999.9s	SEC	9999
1s to 9999s	SEC	9999
1s to 99m 59s	h S	9959
0.1m to 999.9m	h	9999
1m to 9999m	h	9999
1m to 99h 59m	H h	9959
1h to 9999h	H	9999

※ Model : CT4S-2P, CT4S



# Multi-Functional Counter/Timer

## Setting of Timer function modes

(**MD** key : Use the **▲** or **▼** key to Change the setting)

Setting mode	How to set
Time range (SEC / $\bar{n}$ n / Hour)	<p>※The time range for 6digit type</p> <p>※The time range for 4digit type</p>
UP/DOWN mode (U-d)	<p><b>U</b> <math>\rightleftharpoons</math> <b>d</b></p> <p>※Up : Time proceeds from 0(zero) to the set value Down : Time proceeds from the set value to 0(zero)</p>
Output mode (out)	<p>ond <math>\rightarrow</math> ond.1 <math>\rightarrow</math> ond.2 <math>\rightarrow</math> FLY <math>\rightarrow</math> FLY.1 <math>\rightarrow</math> FLY.2 <math>\rightarrow</math> int <math>\rightarrow</math> int.1 <math>\rightarrow</math> ofd</p>
Output time (out.t)	<p>10 <math>\rightarrow</math> 50 <math>\rightarrow</math> 100 <math>\rightarrow</math> 200 <math>\rightarrow</math> 500  <math>\leftarrow</math> Hold <math>\leftarrow</math> 5000 <math>\leftarrow</math> 2000 <math>\leftarrow</math> 1000</p> <p>Unit: ms</p> <p>※It is operation time of control output according to output mode.</p>
Input logic (S.n)	<p><b>nPn</b> : Voltage input <b>PnP</b> : No-voltage input</p> <p>※It indicates according to internal position, and it can't be set by <b>▲</b> &amp; <b>▼</b> key.</p>
Input signal time (int.t)	<p><b>1</b> <math>\rightleftharpoons</math> <b>20</b> Unit: ms</p> <p>※CTS series : Min. external INA, INH, RESET signal width CT series : Min. external INA, INHIBIT, RESET, BATCH, RESET signal width</p>
Lock key(Lock) (LoL)	<p>LoFF <math>\rightarrow</math> LoL.1 <math>\rightarrow</math> LoL.2 <math>\rightarrow</math> LoL.3</p>
Counter/Timer (C-t)	<p>CoUn <math>\rightleftharpoons</math> t, nE</p> <p>※ CoUn : Counter t, nE : Timer</p>

- ※When it is in the function setting mode, no external input signal will be accepted and the output will stay in the OFF status.
- ※In case of output mode is FKL, INT, INT1, OFD, there is no output time setting in the function setting mode.
- ※In the indicator type(CT6Y-I, CT6S-I, CT6-I), there are no output modes or output times in the function setting mode.
- ※Control output operates as OUT2 in the double preset type(CT6Y-2P, CT6S-2P, CT4S-2P, CT6-2P), and OUT1 always remains in "OFF" status.
- ※When in the function setting mode, if no key is touched for 60 sec., the timer will return to RUN mode.

## How to set Lock key

Be sure to set the lock mode in order to protect against accidental or unauthorized key operation.

**LoFF** (LOCK OFF) : Cancellation of the lock mode

**LoL.1** (LOCK LEVEL 1) : Lock **rst** key

**LoL.2** (LOCK LEVEL 2) : Lock **▲** & **▼** & **▲** key

**LoL.3** (LOCK LEVEL 3) : Lock **rst** & **▲** & **▼** & **▲** key

(A)  
Counter

(B)  
Timer

(C)  
Temp.  
controller

(D)  
Power  
controller

(E)  
Panel  
meter

(F)  
Tacho/  
Speed/  
Pulse  
meter

(G)  
Display  
unit

(H)  
Sensor  
controller

(I)  
Proximity  
sensor

(J)  
Photo  
electric  
sensor

(K)  
Pressure  
sensor

(L)  
Rotary  
encoder











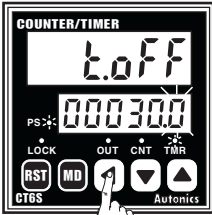

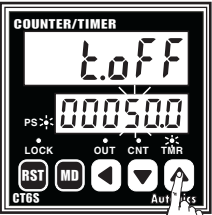
(M)  
5-Phase  
stepping  
motor &  
Driver &  
Controller

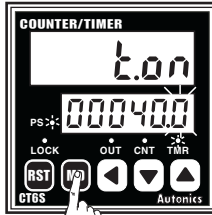
# CTY/CTS/CT Series

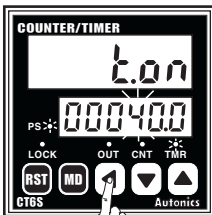
## Change of the setting time of Timer



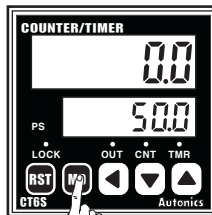





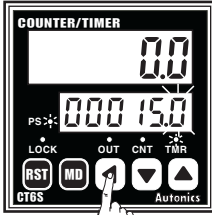

### Change of the setting time in FLK output mode(CT6S)

: Change t.oFF time from 30sec. to 50sec., t.on setting from 40sec. to 20sec.  
(Output mode:FLK, Time range:tr-2)

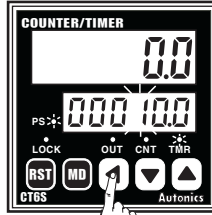
- 1  Pressing  key to enter into the state of changing preset time. Shift the flickering digit to "3" position by pressing  key twice.
- 2  Change "3" to "5" by pressing  twice.
- 3  Pressing  key to complete t.oFF time then enter into the state of changing t.on time.
- 4  Pressing  key twice to move to the "4" position.
- 5  Pressing  key twice to change "4" to "2".
- 6  Pressing  key to complete the setting time then return to RUN mode. (PS LED OFF)

### Change of the preset time when output mode is not FLK(CT6S)

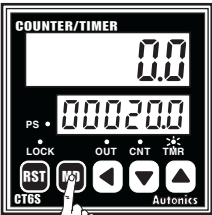
: Change time from 15.0sec. to 20.0sec.(Output mode : OND, Time range : tr-2)

- 1  Pressing  key to enter into the state of changing preset time. Pressing  key once to move to the "5" position.
- 2  Pressing  key 5times to change "5" to "0".
- 3  Pressing  key once to move to "1" position.
- 4  Pressing  key once to change "1" to "2".
- 5  Pressing  key to complete the change of preset time then return to RUN mode of Timer.(PS LED OFF)

- ※ When entering into the state of changing preset time, the time will progress continuously.
- ※ When changing preset value, if no key is touched for 60sec., the timer will return to RUN mode.
- ※ Whenever  key is pressed in the state of changing preset value, the flickering digit shifts from the right to the left.

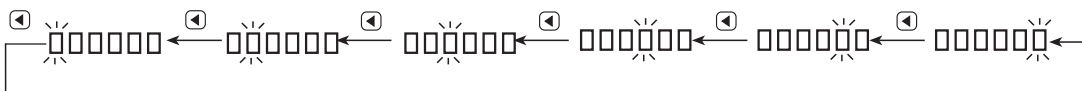

# Multi-Functional Counter/Timer

## ■ Batch Counter function(Timer)

: When it reaches the Batch setting value to count the number of Time-ups, Batch output will be ON.  
But when the output mode is "FLK", the number of Time-ups will be 2 times because it will count both Toff, and Ton time-ups.

- ☞ When time reaches the Toff setting time, Batch counting value will be increased.
- And when it reaches the Ton time, Batch counting value will be increased.

### ◎How to set the Batch setting value

: Batch setting value is not for setting the time, it sets the counting value like a Counter.  
When using it as Timer, the method of Batch setting is the same as Batch setting method of Counter.  
Please see A-18page.

### ◎Batch Counter function

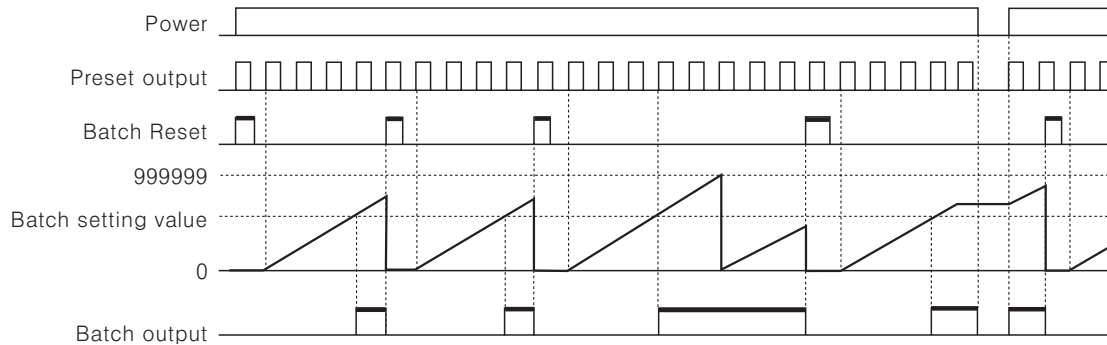

- ※When the batch counting value reaches the batch set value, the batch reset signal is applied and the batch output returns to the OFF state.
- ※When the batch output turns on and if the power turns off and then turns on again, the batch output remains in the ON state until the batch reset signal is applied.
- ※When the batch counting value counts over 999999, it resets to 0(ZERO), and it counts up again.
- ※If batch set value is 0(ZERO), the batch counting value counts up, but the batch output remains OFF state.
- ※The batch counting value is not changed by front **[RST]** key or external reset signal.

### ◎Reset the Batch counting value

When the terminal of Batch RESET is externally short-circuited, the BATCH counting value will be reset.  
But the Batch RESET is different dependent on the input logic setting.

- : When Voltage input type(PNP) is selected, please make terminal numbers **10** and **14** short-circuited.
- And when No-voltage input type(NPN) is selected, please make terminal number of **11** and **14** short-circuited.

### ◎Check the Batch counting value

In order to check the Batch counting value during the Timer operation, press the **[BA]** key to display both the Batch counting value and setting value. After checking Batch counting value, it will return to RUN mode by pressing **[MD]** key.

- ※ There is no **[BA]** key lock function for Batch function.

### ◎Application of Batch counter

: Fill milk into the bottle for 30sec.(Setting time), then when 500 bottles are completed, turn Batch counting finish lamp on. (Setting time : 30sec., Batch setting value : 500)

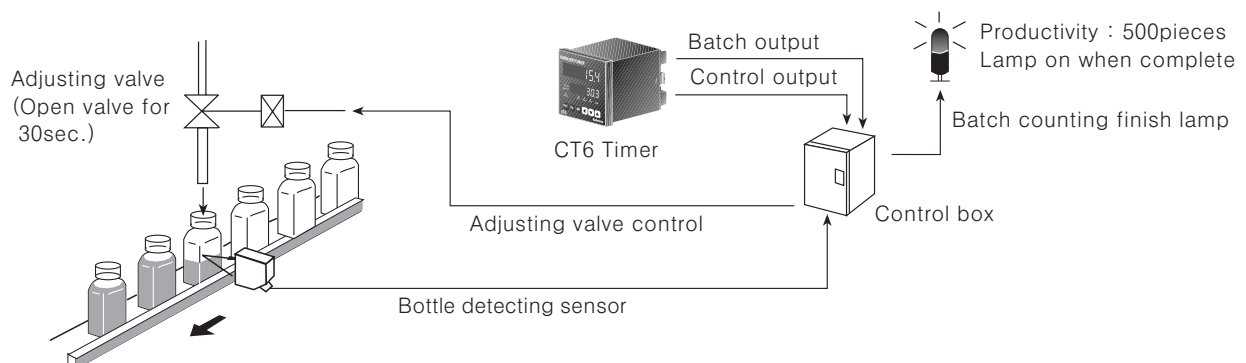

(A)  
Counter

(B)  
Timer

(C)  
Temp.  
controller

(D)  
Power  
controller

(E)  
Panel  
meter

(F)  
Tacho/  
Speed/  
Pulse  
meter

(G)  
Display  
unit

(H)  
Sensor  
controller

(I)  
Proximity  
sensor

(J)  
Photo  
electric  
sensor

(K)  
Pressure  
sensor

(L)  
Rotary  
encoder

(M)  
5-Phase  
stepping  
motor &  
Driver &  
Controller

# CTY/CTS/CT Series

## Output operation mode(Timer)



Output mode	Time chart	Operation
<b>ond</b> (OND)	SIGNAL ON DELAY (POWER RESET)	<ol style="list-style-type: none"> <li>1) Time starts when INA signal turns on. When INA signal turns off, time resets.</li> <li>2) Time starts when power turns on and when reset turns off during INA signal on.</li> <li>3) Control output operates as hold or one-shot time.</li> </ol>
<b>ond.1</b> (OND.1)	SIGNAL ON DELAY 1 (POWER RESET)	<ol style="list-style-type: none"> <li>1) Time starts when INA signal turns on, if INA signal is applied repeatedly, only initial signal is recognized.</li> <li>2) Time starts when power turns on and when reset turns off during INA signal on.</li> <li>3) Control output operates as hold or one-shot time.</li> </ol>
<b>ond.2</b> (OND.2)	POWER ON DELAY (POWER HOLD)	<ol style="list-style-type: none"> <li>1) Time starts when power turns on. (There is no INA function)</li> <li>2) Time resets when reset turns on. Time starts when reset turns off.</li> <li>3) Control output operates as hold output or one-shot output.</li> <li>4) It memorizes display value when power turns off.</li> </ol>

\*POWER RESET : There is no memory retention. (Timer resets to initial value)

\*POWER HOLD : There is memory retention. (It memorizes the indicating value when power is cut off and displays the same value when power returns)

# Multi-Functional Counter/Timer

## Output operation mode(Timer)



- (A) Counter
- (B) Timer
- (C) Temp. controller
- (D) Power controller
- (E) Panel meter
- (F) Tacho/ Speed/ Pulse meter
- (G) Display unit
- (H) Sensor controller
- (I) Proximity sensor
- (J) Photo electric sensor
- (K) Pressure sensor
- (L) Rotary encoder
- (M) 5-Phase stepping motor & Driver & Controller

Output mode	Time chart	Operation
FLV (FLK)	<p style="text-align: center;"><b>FLICKER(POWER RESET)</b></p>	<ol style="list-style-type: none"> <li>Time starts when INA signal turns on. If INA signal is applied repeatedly, only initial signal is recognized.</li> <li>Time starts when power turns on and when reset turns off during INA signal on.</li> <li>Control output operates as hold output, output turns off for the Toff time and turns on for the Ton time repeatedly.</li> <li>The Ton time and the Toff time must be set individually.</li> <li>In case of using the contact output, min. setting time must be set over 100ms.</li> </ol>
	<p style="text-align: center;"><b>FLICKER 1(POWER RESET)</b></p> <p><b>Hold output</b></p>	<ol style="list-style-type: none"> <li>Time starts when INA signal turns on. If INA signal is applied, repeatedly only initial signal is recognized.</li> <li>Time starts when power turns on and when reset turns off during INA signal on.</li> <li>Control output operates as hold output. In case of using the contact output, min. setting time must be set over 100ms.</li> </ol>
FLV.1 (FLK.1)	<p><b>One-shot output</b></p>	<ol style="list-style-type: none"> <li>Time starts when INA signal turns on, if INA signal is applied repeatedly, only initial signal is applied.</li> <li>Time starts when power turns on and when reset turns off during INA signal on.</li> <li>Control output operates as one-shot. In case of using the contact output, min. setting time must be set over 100ms.</li> </ol>

※POWER RESET : There is no memory retention. (Timer resets to initial value)

※POWER HOLD : There is memory retention. (It memorizes the indicating value when power is cut off and displays the same value when power returns)

# CTY/CTS/CT Series

## Output operation mode(Timer)

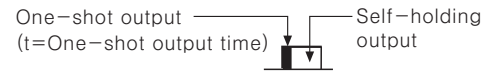

Output mode	Time chart	Operation
<b>FLK.2 (FLK.2)</b> ※EEPROM:10 years	<b>FLICKER 2(POWER HOLD)</b> <b>Hold output</b> 	1)Time starts when INA signal turns ON. If INA signal is applied repeatedly, only initial signal is recognized. 2)Control output operates as hold output when reaches to the set time. 3)Time starts when power turns ON and when reset turns OFF during INA signal on. 4)In case of using the contact output, min. setting time must be set over 100ms.
	<b>One-shot output</b> 	1)Time starts when INA signal turns ON. If INA signal is applied repeatedly, only initial signal is recognized. 2)Control output operates as one-shot output when reaches to the set time. 3)Time starts when power turns ON and when reset turns OFF during INA signal on. 4)In case of using the contact output, min. setting time must be set over 100ms.
<b>INT (INT)</b>	<b>INTERVAL(POWER RESET / SIGNAL RESET)</b> 	1)During INA is ON, time starts and control output turns on. When time reaches to set value, display value and control output will be reset automatically. 2)When INA is OFF, time resets. 3)During INA signal on Power OFF:Processing time and control output Reset Power ON:Time Reset Reset ON:Processing time and control output Reset Rset OFF:Time Reset

※POWER RESET : There is no memory retention. (Timer resets to initial value)

※POWER HOLD : There is memory retention. (It memorizes the indicating value when power is cut off and displays the same value when power returns)

# Multi-Functional Counter/Timer

## Output operation mode(Timer)



Output mode	Time chart	Operation
<b>int.1</b> (INT.1)	INTERVAL 1 (POWER RESET)	<ol style="list-style-type: none"> <li>Control output turns ON and time starts when INA signal turns ON.</li> <li>If INA signal is applied repeatedly, only initial signal is recognized.</li> <li>When reaches to set value, display value and control output are reset automatically.</li> <li>Time starts when power turns ON and when reset turns OFF during INA signal on.</li> <li>Time processes normally while INA signal keeps ON status.</li> </ol>
	SIGNAL OFF DELAY (POWER RESET)	

※POWER RESET : There is no memory retention. (Timer resets to initial value)

## Timer operation of Indication model(CT6-I, CT6S-I)

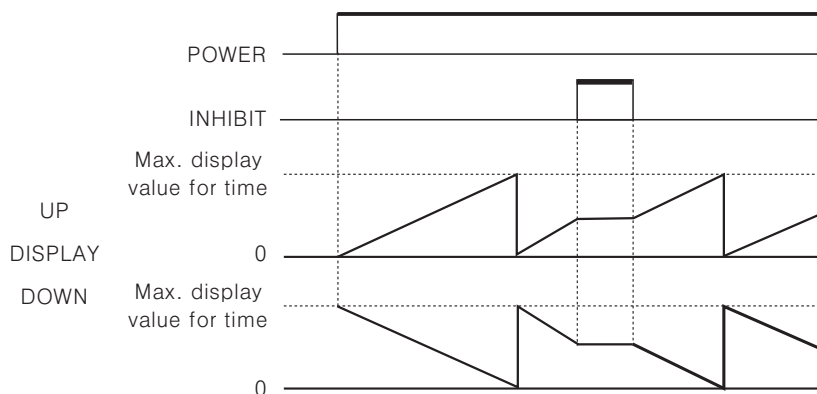

(A)  
Counter

(B)  
Timer

(C)  
Temp.  
controller

(D)  
Power  
controller

(E)  
Panel  
meter

(F)  
Tacho/  
Speed/  
Pulse  
meter

(G)  
Display  
unit

(H)  
Sensor  
controller

(I)  
Proximity  
sensor

(J)  
Photo  
electric  
sensor

(K)  
Pressure  
sensor

(L)  
Rotary  
encoder

(M)  
5-Phase  
stepping  
motor &  
Driver &  
Controller

# CTY/CTS/CT Series

---

## ■ Proper usage

### ◎ Turning power ON/OFF

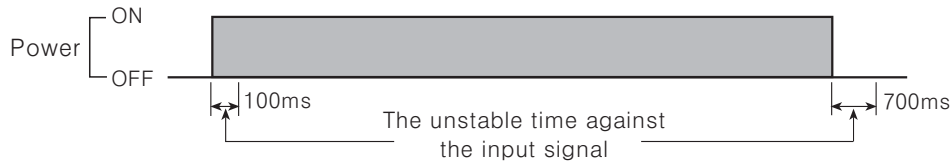

- Power voltage rises for 100ms after power on and falls for 700ms after power off. Therefore do not apply any input signal during these times.
- When applying the power into CT series, please apply the power quickly by using Switch or Relay.

### ◎ Input signal line

- Use as short a cable from the sensor to this unit as possible.
- Use shielded cable for long input line.
- Keep input cables separate from power cables.

### ◎ Input logic selection

When selecting or changing the input logic, the power source must be cut off. Then select the input logic according to the method of changing input logic.

### ◎ Contact counting input

If applying contact input at high speed mode (1k, 5k, 10k), it may miscount by chattering. Therefore, set low speed mode. (1 or 30cps)

### ◎ When testing dielectric voltage and insulation resistance of the control panel with this unit installed.

- Please isolate this unit from the circuit of control panel.

### ◎ Do not use this unit in the following places

- A Place where ambient temperature is over 55°C or less than -10°C.
- A Place where ambient humidity is over 85%RH or where condensation occurs by temperature changes.
- A Place where there is severe vibration or impact.
- A Place where strong magnetic field or electric noise is generated.
- A Place where strong alkalis or acids are used.
- A Place where there are direct rays of the sun.

### ◎ Use under these conditions

- Indoors
- Maximum height 2000m
- Pollution Degree 2
- Installation category II

**※ Above cautions must be kept because malfunction or failure of unit can be occurred.**